

## Box-PC Barebone BPCRL02-i5

Intel Core i5-1335U Processor

### FANLESS BOX-PC WITH INTEL CORE PROCESSOR IN A ROBUST CHASSIS

Shuttle's BPCRL02 fanless Box-PC Series is fueled by Intel's 13th Generation ("Raptor Lake") Core processors in a ruggedized box design for high durability. It comes with modular I/O expansion capabilities and various mounting options. With advanced technology and highly flexible design, this industrial PC offers a reliable solution for a wide range of customized requirements in industrial environments.



Rear View

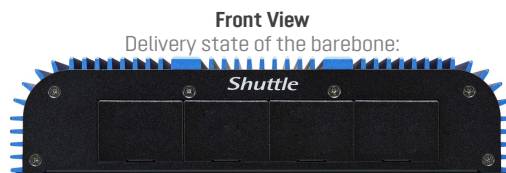

Front View  
Delivery state of the barebone:



Example illustration with optional connections:

Images for illustration only

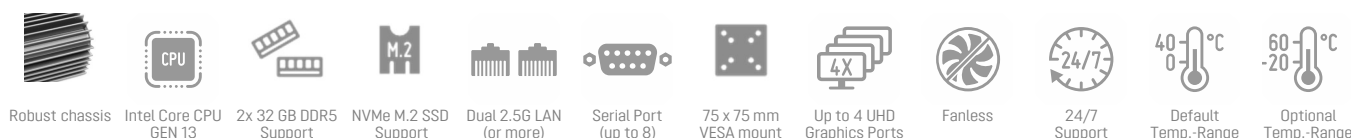

#### ROBUST CHASSIS

- Fanless cooling system ■ Robust aluminium/steel chassis
- Dimensions (LWH): 16.9 x 24.5 x 5.7 cm (2.7 L) ■ Net weight: 2.85 kg
- IP Rating: IP30 ■ Mounting options: VESA, Ear mount and DIN Rail

#### OPERATING TEMPERATURE RANGE [1]

- **Standard:** 0 – +40 °C ■ **Industry:** -20 – +60 °C (Optional [1])
- Operating humidity: 20 ~ 80% (non-condensing)

#### OPERATING SYSTEM SUPPORT

- An operating system is not included.
- Supports Windows 11 and Linux (64-bit)

#### PROCESSOR

- intel Core i5 -1335U Gen. 13 "Raptor Lake" ULV processor, 15 W TDP
- Integrated Intel® Iris® Xe Graphics supports up to four UHD displays

#### RAM/SSD SUPPORT

- 2x 262-pin SO-DIMM slot ■ Supports up to 2x 32 GB DDR5-5200
- M.2-2280M slot supports one SSD card (PCIe X4 NVMe or SATA)

#### BACK PANEL CONNECTORS

- HDMI 2.0b ■ 4x USB 3.2 Gen 2 ■ Dual 2.5G LAN ■ COM Port RS232
- Mic-in and Line-out ■ DC-input (2.5/5.5 mm) ■ Power Button

#### OTHER FEATURES

- Hardware TPM v2.0 Infineon SLB9670VQ2 onboard

#### OPTIONAL FRONT PANEL CONNECTORS

- Up to three additional graphics ports: HDMI 2.0b, HDMI 1.4, DVI-I, DisplayPort 1.2 or VGA
- Up to 7 additional COM ports
- Up to 8 (16) additional USB 2.0 ports
- Up to four additional 2.5 Gbps LAN ports
- Up to four Digital I/O expansion kits (each with 4x Input and 4x Output)
- Input for car ignition lock enables delayed on/off switching of the PC
- Terminal screw connector for external power button and/or DC-Input

#### LTE/WLAN OPTIONS

- LTE/4G kit with 2 antennas (LTE card and Nano-SIM not included)
- WLAN kit with 2 antennas Wi-Fi 6E (ax)

#### POWER SUPPLY

- DC-Input: 19V – optional wide range DC-input 9~36V
- External 90W/19V power adapter [1]



#### Models of the BPCRL02 series

Shuttle Model	Intel Gen12 ULV Processor	Cores (Threads)		Base/Turbo Clock		Smart Cache	Intel Graphics			TDP	UPC Bar Code
		P	E	P	E		Type	Max. Clock	EUs		
BPCRL02-i3	Core i3-1315U	2 (4)	4 (4)	1.2 / 4.5 GHz	0.9 / 3.3 GHz	10 MB	UHD	1.25 GHz	64	15 W	887993008332
<b>BPCRL02-i5</b>	Core i5-1335U	2 (4)	8 (8)	1.3 / 4.6 GHz	0.9 / 3.4 GHz	12 MB	Iris Xe	1.25 GHz	80	15 W	887993008325
BPCRL02-i7	Core i7-1355U	2 (4)	8 (8)	1.7 / 5.0 GHz	1.2 / 3.7 GHz	12 MB	Iris Xe	1.30 GHz	96	15 W	887993008318

[1] For the extended operating temperature range (-20 to +60°C) a special 150W power supply (Order No. PA1501) and industrial-grade RAM/SSD components with an operating temperature range of -40 ... +85 °C are required.

**Caution:** Only suitably trained persons may open the barebone and install optional components!

## Front and Back Panel

Front panel

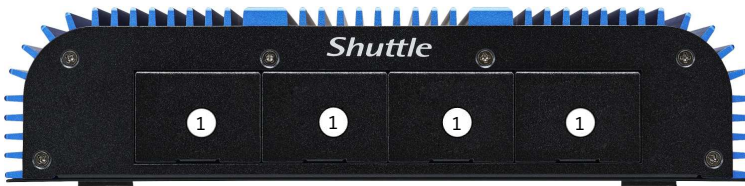

Back panel



1. The front panel has four sections to support optional I/O expansion kits

Example for optional I/O ports:



2. Audio Line Out (Headphones output)
3. Microphone input
4. 2.5G LAN Port (Intel i226V, black)
5. 2.5G LAN Port (Intel i226V, yellow)
6. 4x USB 3.2 Gen 2 Type A Port
7. HDMI 2.0b Port
8. COM port (RS232)
9. DC-in connector for power adapter
10. Power button
11. 2x WLAN antenna (optional)

Inside View

Front Panel



Back Panel

12. Area for optional daughter boards
13. 2x SO-DIMM slot supports DDR5-5200
14. M.2-2280/2242 M slot for SSD card (NVMe/SATA)
15. Screw threads for VESA mount (75x75 mm)

Dimensions

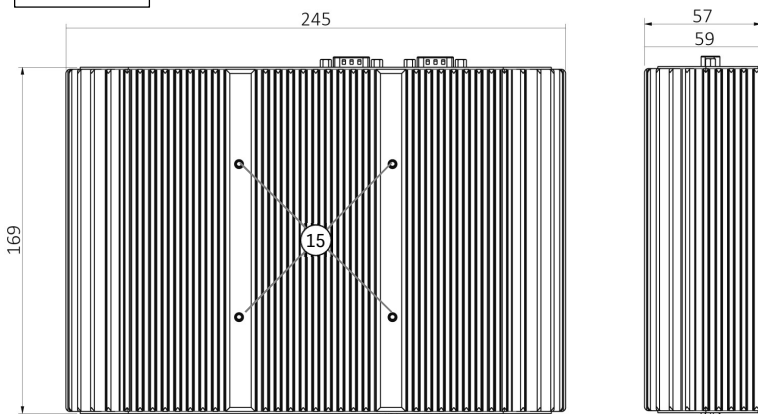

### Dimensions:

Width: 245 mm (without optional ear mount)  
 Depth: 169 mm  
 Height: 57 mm (59 mm including feet)

## Barebone models and optional accessories

**Caution:** Only suitably trained persons may open the barebone and install optional components

<p>Processor</p>	<p>The processor is permanently soldered onto the mainboard. The desired processor is selected with the barebone version:</p> <table border="1"> <thead> <tr> <th>Shuttle BoxPC Barebone Model</th> <th>Processor</th> <th>P-Cores (Threads)</th> <th>P-Cores Clock / GHz</th> <th>E-Cores</th> <th>E-Cores Clock / GHz</th> <th>Cache</th> <th>Graphics</th> </tr> </thead> <tbody> <tr> <td><b>BPCRL02-i3</b></td> <td>Intel Core i3-1315U</td> <td>2 (4)</td> <td>1.2 - 4.5</td> <td>4</td> <td>0.9 - 3.3</td> <td>10 MB</td> <td>Intel UHD</td> </tr> <tr> <td><b>BPCRL02-i5</b></td> <td>Intel Core i5-1335U</td> <td>2 (4)</td> <td>1.3 - 4.6</td> <td>8</td> <td>0.9 - 3.4</td> <td>12 MB</td> <td>Intel Iris Xe</td> </tr> <tr> <td><b>BPCRL02-i7</b></td> <td>Intel Core i7-1355U</td> <td>2 (4)</td> <td>1.7 - 5.0</td> <td>8</td> <td>1.2 - 3.7</td> <td>12 MB</td> <td>Intel Iris Xe</td> </tr> </tbody> </table>	Shuttle BoxPC Barebone Model	Processor	P-Cores (Threads)	P-Cores Clock / GHz	E-Cores	E-Cores Clock / GHz	Cache	Graphics	<b>BPCRL02-i3</b>	Intel Core i3-1315U	2 (4)	1.2 - 4.5	4	0.9 - 3.3	10 MB	Intel UHD	<b>BPCRL02-i5</b>	Intel Core i5-1335U	2 (4)	1.3 - 4.6	8	0.9 - 3.4	12 MB	Intel Iris Xe	<b>BPCRL02-i7</b>	Intel Core i7-1355U	2 (4)	1.7 - 5.0	8	1.2 - 3.7	12 MB	Intel Iris Xe
Shuttle BoxPC Barebone Model	Processor	P-Cores (Threads)	P-Cores Clock / GHz	E-Cores	E-Cores Clock / GHz	Cache	Graphics																										
<b>BPCRL02-i3</b>	Intel Core i3-1315U	2 (4)	1.2 - 4.5	4	0.9 - 3.3	10 MB	Intel UHD																										
<b>BPCRL02-i5</b>	Intel Core i5-1335U	2 (4)	1.3 - 4.6	8	0.9 - 3.4	12 MB	Intel Iris Xe																										
<b>BPCRL02-i7</b>	Intel Core i7-1355U	2 (4)	1.7 - 5.0	8	1.2 - 3.7	12 MB	Intel Iris Xe																										
<p>Storage</p>	<p>Install memory components into the barebone system that you purchase from a specialized dealer:</p> <ol style="list-style-type: none"> <li><b>up to 2x 32 GB DDR5 SO-DIMM</b> (DDR5-5200 or higher)</li> <li><b>one M.2-2280 SSD card</b> with PCIe/NVMe or SATA interface</li> </ol>																																
<p>Operating-temperature</p>	<p>The <b>permissible operating temperature</b> range with standard components is <b>0 ... +40 °C</b>.</p> <p>The <b>extended temperature range of -20 ... +60°C</b> is only permissible with the following components:</p> <ol style="list-style-type: none"> <li><b>special 150W power adapter</b> with order no. <b>PA1501</b></li> <li><b>industrial-grade RAM/SSD components</b> with an operating temperature range of <b>-40 ... +85 °C</b></li> </ol>																																
<p>Mounting</p>	<p>The BoxPC can be placed horizontally on its rubber feed or can be mounted in the following three ways:</p> <table border="1"> <thead> <tr> <th>Mounting Method</th> <th>Accessory Product</th> </tr> </thead> <tbody> <tr> <td>VESA-mount, 75x75 mm</td> <td>from specialised dealers</td> </tr> <tr> <td>Ear mount brackets (on both sides)</td> <td><b>MRS01</b></td> </tr> <tr> <td>Two clips for DIN Rail mounting</td> <td>2x <b>MDR01</b></td> </tr> </tbody> </table> <p>See explanations on the next page</p>	Mounting Method	Accessory Product	VESA-mount, 75x75 mm	from specialised dealers	Ear mount brackets (on both sides)	<b>MRS01</b>	Two clips for DIN Rail mounting	2x <b>MDR01</b>																								
Mounting Method	Accessory Product																																
VESA-mount, 75x75 mm	from specialised dealers																																
Ear mount brackets (on both sides)	<b>MRS01</b>																																
Two clips for DIN Rail mounting	2x <b>MDR01</b>																																
<p>WLAN</p>	<p>Perforations provided on the back panel of the BoxPC for mounting the WLAN antennas.</p> <table border="1"> <thead> <tr> <th>Description</th> <th>Accessory Product</th> </tr> </thead> <tbody> <tr> <td>2x external antenna cable, 2x thermal pad</td> <td><b>CWL01</b></td> </tr> <tr> <td>M.2-2230 WLAN card</td> <td>optional</td> </tr> </tbody> </table>	Description	Accessory Product	2x external antenna cable, 2x thermal pad	<b>CWL01</b>	M.2-2230 WLAN card	optional																										
Description	Accessory Product																																
2x external antenna cable, 2x thermal pad	<b>CWL01</b>																																
M.2-2230 WLAN card	optional																																
<p>Extended Voltage Range</p>	<p>The DC input connector (2.5 / 5.5 mm) supports 19V input voltage and a suitable 90W power adapter is included in the scope of delivery.</p> <p>To be able to use other power sources, the input voltage range can be extended to 9 ... 36 V DC by adding the optional voltage regulator modul with order no. <b>VOLO1</b>.</p>																																

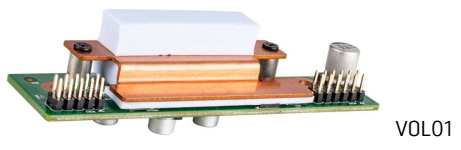
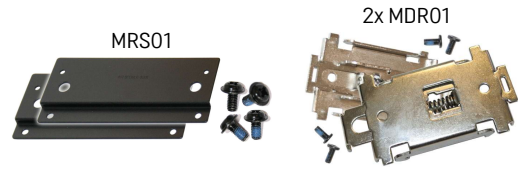
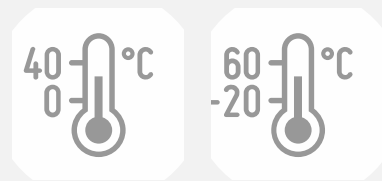
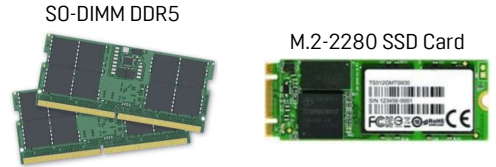

## Optional I/O Ports Front Panel













### Expansion concept with optional daughter boards

The front panel is subdivided into four sections to support optional expansion kits in order to add I/O ports.



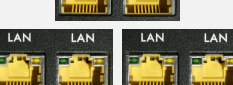
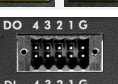

Every optional expansion kit is required to start from Section 1 (on the right) with the second kit occupying Section 2 etc. Some kits occupy two sections.

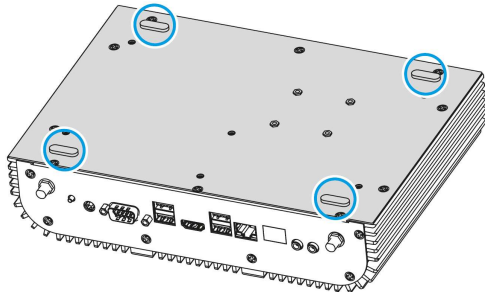
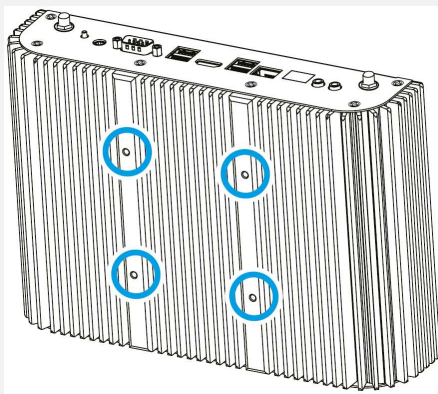
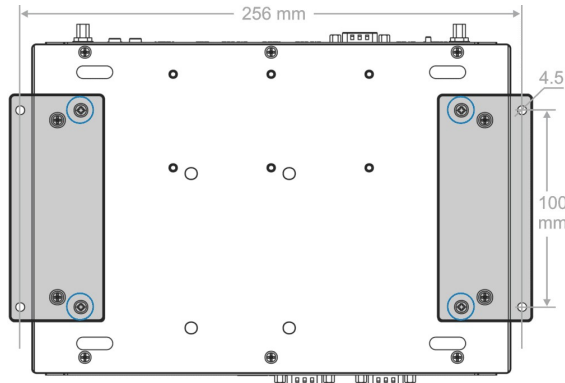

### Expansion options:

PORT	ORDER No.	IMAGE	OCCUPIED SECTIONS	MAXIMUM KITS	NOTE
HDMI 2.0b HDMI 1.4 DP 1.2 DVI-I VGA	<b>DHD11</b> <b>DHDO1</b> <b>DDPO1</b> <b>DDVO1</b> <b>DVGO1</b>	 	1	3	1) One HDMI 2.0b port is in the back panel (fix). 2) Three additional graphics ports can be added: HDMI 2.0b, HDMI 1.4, DisplayPort 1.2, DVI-I or VGA. <u>Note:</u> the fourth graphics port is limited to DisplayPort or VGA and is not Plug&Play-capable.
4x USB 2.0	<b>USB01</b>		1	2 (4)	USB hub device (USB 2.0 ports allow up to 500mA/2.5W power output, but if only low power devices like mouse/keyboard are connected, then up to 4 USB kits can be used)
Single COM	<b>CRS01</b>		1	1	Supports RS232 only (passive cable adapter)
Dual COM	<b>CSD01</b>		2	1	Supports RS232/RS422/RS485 (with additional I/O controller chip)
4x COM	<b>CSD04</b>		2	1	Supports 2x RS232/RS422/RS485 and 2x RS232 (only available in Shuttle's Systems Configurator)
6x COM	<b>CSD06</b>		3	1	Supports 2x RS232/RS422/RS485 and 4x RS232 (only available in Shuttle's Systems Configurator)
LTE/4G Kit with 2 antennas	<b>LTE01</b>		2	1	Not included: M.2 LTE/4G card and Nano SIM card Compatible with e.g. Huawei ME906S, Sierra EM7455, Quectel EM06E, SIMCom SIM7600G-H R2 LTE, Techship Telit LE910C4-WWXd LTE, etc.
2x LAN ports 4x LAN ports with 2.5 Gbps	2x LAN: <b>LAN22</b> 4x LAN: <b>LAN42</b>	 	1 or 2	1	In addition to the existing 2x 2.5G LAN ports you can add up to four LAN ports with 2.5G speed <u>Note:</u> then only M.2 SSD cards with SATA interface are supported (no more PCIe/NVMe)
Dig. I/O-Kit 4x In / 4x Out	<b>DI011</b>		1	4	up to four Digital I/O expansion kits each with 4x Input and 4x Output
Input for car ignition lock	<b>DI001</b>		1	1	Input for car ignition lock enables delayed on/off switching of the BoxPC
Screw terminal	for external Power Button: <b>PWR01</b>		1	1	Screw terminal for: - an external power button (PWR01) - an external DC power source (both connections can be fitted simultaneously)
	for DC Input: <b>PDC01</b>		1	1	
Screw terminal	for external Power Button and DC Input <b>PDC11</b>		1	1	Supports connector for external Power Button (or ignition lock) and DC-Input Available in Shuttle's Systems Configurator. <u>Note:</u> Wide-Voltage Module (VOL01) and special BIOS Update is required for PDC11.

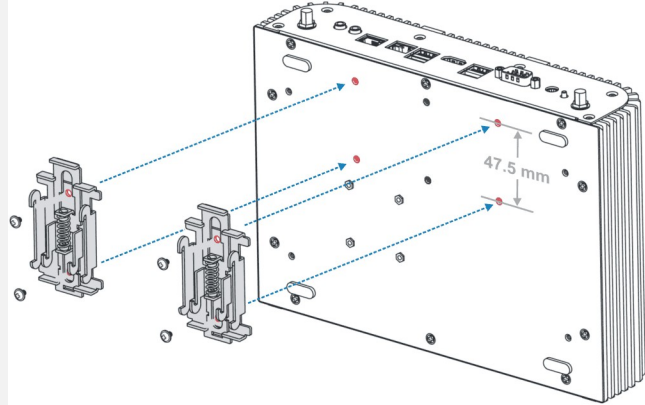
## Operating Positions and Mounting

	NOTE	IMAGE
Placed horizontally	The Shuttle Box-PC series BPCRL02 can be operated in horizontal position like a desktop PC standing on its rubber feet.	
VESA-mounted	The Shuttle Box-PC series BPCRL02 features four threaded M4 holes on the upper side for a standard 75 x 75 mm VESA mount, which allows for installation on to walls or large displays. The VESA mount is not included.	
Ear-mounted	The Shuttle Box-PC series BPCRL02 features four threaded M3 holes on the bottom, which allows for it to be attached to two Ear Mount brackets (optional accessory <b>MRS01</b> ). The Box-PC can then be affixed to a surface with four M4 screws (mounting dimension: 256 mm x 100 mm).	 
DIN-Rail-mounted	The Shuttle Box-PC series BPCRL02 features several threaded M3 holes on the bottom, which allows for installation of two DIN-Rail clips to mount this PC on a standard 35 mm DIN-Rail, e.g. inside equipment racks. The matching DIN-Rail clips are an optional accessory (2x <b>MDR01</b> ) – please use two of them as shown in the picture.	 

## Shuttle Product Comparison

Shuttle Box-PC Model	<b>BPCRL02 Series</b>	<b>BPCAL02 Series</b>	<b>BPCWL02 Series</b>
Processor Generation	<b>Intel Core Gen. 13</b> Code name: " <b>Raptor Lake-U</b> ", TDP= 15W Intel 7 (10 nm) Technology	<b>Intel Core Gen. 12</b> Code name: " <b>Alder Lake-U</b> ", TDP= 15W Intel 7 (10 nm) Technology	<b>Intel Core Gen. 8</b> Code name: " <b>Whiskey Lake-U</b> ", TDP= 15W 14 nm Technology
Processor Model	<b>BPCRL02-i3</b> : Intel Core i3-1315U <b>BPCRL02-i5</b> : Intel Core i5-1335U <b>BPCRL02-i7</b> : Intel Core i7-1355U	<b>BPCAL02-i3</b> : Intel Core i3-1215U <b>BPCAL02-i5</b> : Intel Core i5-1235U <b>BPCAL02-i7</b> : Intel Core i7-1255U	<b>BPCWL02-i3</b> : Intel Core i3-8145UE <b>BPCWL02-i5</b> : Intel Core i5-8365UE <b>BPCWL02-i7</b> : Intel Core i7-8365UE
RAM Support	2x SO DIMM, 262 pins max. 2x 32 GB <b>DDR5-5200</b> (or higher)	2x SO DIMM, 262 pins max. 2x 32 GB <b>DDR5-4800</b> (or higher)	2x SO DIMM, 260 pins max. 2x 32 GB <b>DDR4-2400</b> (or higher)
Graphics Engine	Core i5/i7: Intel Iris Xe Core i3: Intel UHD Graphics	Core i5/i7: Intel Iris Xe Core i3: Intel UHD Graphics	Intel UHD Graphics
Graphics Ports	<b>HDMI 2.0</b> fixed Optional: 3 additional ports	<b>HDMI 2.0</b> fixed Optional: 3 additional ports	<b>HDMI 1.4</b> fixed Optional: 2 additional ports
Dual LAN onboard	1) Intel i226V ( <b>2.5 Gbps</b> ) 2) Intel i226V ( <b>2.5 Gbps</b> ) Optional: 2 or 4 additional ports	1) Intel i226V ( <b>2.5 Gbps</b> ) 2) Intel i226V ( <b>2.5 Gbps</b> ) Optional: 2 or 4 additional ports	1) Intel i211 ( <b>1 Gbps</b> ) 2) Intel i219LM ( <b>1 Gbps</b> ) Optional: 4 additional ports
M.2-2280 Slot	M.2-2280 slot for M.2 SSD cards with <b>80 and 42 mm</b> length Supports NVMe/PCIe <b>Gen4</b> X4 and SATA	.2-2280 slot for M.2 SSD cards with <b>80 and 42 mm</b> length Supports NVMe/PCIe <b>Gen4</b> X4 and SATA	.2-2280 slot for M.2 SSD cards with <b>80 and 60 mm</b> length Supports NVMe/PCIe <b>Gen3</b> X4 and SATA

## SHUTTLE Box-PC Barebone BPCRL02-i5 — SPECIFICATIONS

**Caution:** Only suitably trained persons may open the barebone and install optional components!

<b>FANLESS AND SILENT</b>	Equipped with passive cooling, no fan noise at all Perfect to be used in noise-sensitive environments Fanless, dust-free and thus virtually maintenance-free																				
<b>24/7 NONSTOP OPERATION</b>	This device is approved for 24/7 permanent operation. Requirement: Free circulation of air amongst the PC must be guaranteed.																				
<b>CHASSIS</b>	Durable and rugged chassis made of aluminium and steel. Passive cooling system with specially designed fins to maximize heat dissipation. Dimensions: 16,9 x 24,5 x 5,7 cm (LWH) = approx. 2,7 litres Weight: 2.85 kg net (Barebone without RAM/SSD and optional expansions) IP-rating: IP30																				
<b>OPERATING POSITIONS AND MOUNTING</b>	<p>1) <b>Desktop:</b> The unit can be placed horizontally to stand on its feet.</p> <p>2) <b>VESA Mount:</b> The unit can be affixed to a 75 mm x 75 mm VESA bracket. For this purpose, four M4x6L screws are required to be screwed into the chassis from the top.</p> <p>3) <b>Side Brackets (MRS01 = 2 brackets):</b> The unit can be mounted using two optional 256 mm x 100 mm ear-mount brackets. For this purpose, four M3x6L screws are required to be screwed into the chassis from the bottom.</p> <p>4) <b>DIN-Rail Clips (2x MDR01):</b> Mounted on a standard 35 mm DIN-Rail, e.g. inside equipment racks. This requires two standard DIN rail clips, each of which is attached to the underside of the BoxPC with two M3 screws (hole spacing: 47.5 mm). Notes: VESA bracket, Ear-Mount and DIN-Rail clips are not included. Vertical mounting is permitted in any orientation.</p>																				
<b>OPERATING SYSTEM</b>	This barebone system comes without operating system. It is compatible with Windows 11 (64-bit) and Linux (64-bit).																				
<b>PROCESSOR</b>	<p>Model: Intel Core i5-1335U Code name: Raptor Lake-U (13th generation Intel Core) Performance-cores (P-Cores): 2 cores (4 threads), Basic/Turbo clock: 1.3-4.6 GHz Efficient-cores (E-Cores): 8 cores (8 threads), Basic/Turbo clock: 0.9-3.4 GHz Smart-Cache (L3): 12 MB Base Power (PL1 TDP): max. 15 W Maximum Tjunction Temperature: 100 °C System-on-a-chip architecture (SoC) with integrated memory and graphics controller BGA1700 package - directly soldered onto the mainboard Lithography: Intel 7 process (10 nm Enhanced SuperFin)</p>																				
<b>INTEGRATED GRAPHICS</b>	<p>Intel® Iris® Xe Graphics GPU clock frequency: max. 1250 MHz Execution Units (EUs): 80 Supports up to four independent screens with up to 4K/60Hz (Ultra HD 3840×2160 resolution).</p> <table border="1" style="width: 100%; border-collapse: collapse;"> <thead> <tr> <th>Display</th> <th>Connector outside</th> <th>Connector onboard</th> <th>Note</th> </tr> </thead> <tbody> <tr> <td>No. 1</td> <td>HDMI 2.0b (on the back panel)</td> <td>—</td> <td>built-in (fixed)</td> </tr> <tr> <td>No. 2</td> <td>optional: HDMI, DP, DVI-I, VGA</td> <td>21-pin DDI onboard</td> <td></td> </tr> <tr> <td>No. 3</td> <td>optional: HDMI, DP, DVI-I, VGA</td> <td>21-pin DDI onboard</td> <td></td> </tr> <tr> <td>No. 4</td> <td>optional: DP, VGA</td> <td>31-pin eDP onboard</td> <td>no PnP *)</td> </tr> </tbody> </table> <p>*) Note: the fourth connector does not support Plug-and-Play The following optional accessories are available for additional graphics connections:            1) HDMI 1.4 (<b>DHD01</b>)            2) HDMI 2.0b (<b>DHD11</b>)            3) DisplayPort 1.2 (<b>DDP01</b>)            4) DVI-I (<b>DDV01</b>)            5) VGA / D-Sub (<b>DVG01</b>)</p>	Display	Connector outside	Connector onboard	Note	No. 1	HDMI 2.0b (on the back panel)	—	built-in (fixed)	No. 2	optional: HDMI, DP, DVI-I, VGA	21-pin DDI onboard		No. 3	optional: HDMI, DP, DVI-I, VGA	21-pin DDI onboard		No. 4	optional: DP, VGA	31-pin eDP onboard	no PnP *)
Display	Connector outside	Connector onboard	Note																		
No. 1	HDMI 2.0b (on the back panel)	—	built-in (fixed)																		
No. 2	optional: HDMI, DP, DVI-I, VGA	21-pin DDI onboard																			
No. 3	optional: HDMI, DP, DVI-I, VGA	21-pin DDI onboard																			
No. 4	optional: DP, VGA	31-pin eDP onboard	no PnP *)																		
<b>UEFI BIOS</b>	<p>Supports resume after power failure Supports Wake on LAN (WOL) Supports Power on by RTC Alarm Supports boot from M.2 SSD cards and USB devices AMI BIOS in 64 MB EEPROM with SPI interface Supports hardware monitoring and Watchdog function Supports Unified Extensible Firmware Interface (UEFI) Supports Intel vPro Essential</p>																				
<b>TPM MODULE</b>	H/W-TPM V2.0: Hardware Trusted Platform Module V2.0 (Infineon SLB9670VQ2)																				
<b>BUTTON CELL BATTERY</b>	The product contains a built-in 3V button cell battery For further information see footnote [3]																				

	Power Adapter	Operating Temperature	Output Wattage	AC Input	DC Output	AC Cable
POWER ADAPTER [1]	Supplied model	0 to +40°C	Max. 90 W	100-240V, 50/60Hz	19V, max. 4.74A	Schuko to IEC 60320 C5
	<b>PA1501</b> (optional)	-20 to +60°C	Max. 150 W (95W at 60°C)	90-260V, 50/60Hz	19V, max. 7.89A	Schuko to IEC 60320 C13
<p>DC Connector: 5.5 / 2.5 mm (outer/inner diameter)</p> <p>AC mains cable: 3 pins, ca. 1.8 m length, with C5/C6 coupler (called "Mickey Mouse" or "Clover-leaf") for the power adapter and CEE-7/7 plug with earth-contact (type E+F) for the power outlet</p> <p>Note: The DC input voltage range can optionally be extended from 19V to support 9-36 V (Accessory <b>VOLO1</b>).</p>						
MEMORY SUPPORT [1]	<p>2x SO-DIMM slot with 262 pins</p> <p>Supports DDR5-5200 (PC5-41600) SDRAM at 1.1 V</p> <p>Supports memory modules with higher frequency rating (e.g. DDR5-6400)</p> <p>Supports Dual Channel mode</p> <p>Supports a maximum of 48 GB per DIMM, maximum total size: 96 GB</p> <p>Supports two unbuffered SO-DIMM modules (no ECC or registered)</p>					
M.2 SLOT FOR SSDs [1]	<p>The M.2 2280 M slot provides the following interfaces:</p> <ul style="list-style-type: none"> <li>- PCI-Express Gen. 4.0 X4</li> <li>- SATA v3.0 (max. 6 Gbps)</li> </ul> <p>It supports M.2 cards with a width of 22 mm and a length of 42 or 80 mm (type 2242, 2280).</p> <p>Supports M.2 SATA SSDs (with B+M key) and M.2 PCIe NVMe SSDs (with M key) with auto detect</p>					
AUDIO	<p>Audio Realtek® ALC888S High-Definition Audio</p> <p>Two analog audio connectors (3.5 mm) on the back panel:</p> <ol style="list-style-type: none"> <li>1) 2 channel line out (headphones)</li> <li>2) microphone input</li> </ol> <p>Digital multi-channel audio output: via HDMI and optional DisplayPort</p>					
DUAL 2.5G LAN	<p>Dual network with RJ45 ports and Intel i226V network chips</p> <p>Supports 10 / 100 / 1000 / 2500 MBit/s operation</p> <p>Supports WAKE ON LAN (WOL)</p> <p>Supports network boot by Preboot eXecution Environment (PXE)</p>					
BACK PANEL CONNECTORS	<p>HDMI 2.0b</p> <p>4x USB 3.2 Gen 2 Type A (max. 10 Gbps)</p> <p>2x Intel 2.5G LAN (RJ45, i226V)</p> <p>Serial COM port (RS232)</p> <p>Microphone input (3.5 mm)</p> <p>Audio Line-out / Headphones (3.5 mm)</p> <p>DC-input connector for external power adapter (2.5 / 5.5 mm)</p>					
OPTIONAL FRONT PANEL CONNECTORS	<p>The front panel is subdivided into four sections to support optional expansion kits with daughter boards in order to add I/O ports. Caution: Only suitably trained persons may open the barebone and install optional components!</p> <ol style="list-style-type: none"> <li>1) up to three additional graphics ports: <ul style="list-style-type: none"> <li>- HDMI 1.4 (<b>DHD01</b>)</li> <li>- HDMI 2.0b (<b>DHD11</b>)</li> <li>- DisplayPort 1.2 (<b>DDP01</b>)</li> <li>- DVI-I (<b>DDV01</b>)</li> <li>- D-Sub/VGA (<b>DVG01</b>)</li> </ul> <p>Attention: only two additional HDMI and DVI ports are possible</p> </li> <li>2) one COM port RS232 (<b>CRS01</b>)</li> <li>3) two COM ports RS232/RS422/RS485 - occupies two sections (<b>CSD01</b>)</li> <li>4) four or six COM ports - occupies two or three sections (<b>CSD04</b> or <b>CSD06</b>)</li> <li>5) 4x USB 2.0 - can be installed twice (Note: USB 2.0 ports allow up to 500mA/2.5W power output, but if only low power devices like mouse/keyboard are connected, then up to 4 USB kits can be used) (<b>USB01</b>)</li> <li>6) up to four Digital I/O expansion kits, each with 4x Input and 4x Output (<b>DIO11</b>) [2]</li> <li>7) Input for car ignition lock enables delayed on/off switching of the BoxPC (<b>DIO01</b>)</li> <li>8) LTE/4G kit with two external Antennas (<b>LTE01</b>). Not included: LTE card in M.2-3042 format (e.g. Huawei ME906S, Sierra EM7455, Quectel EM06E) and Nano-SIM card.</li> <li>9) Terminal connector for an external Power Button (<b>PWR01</b>)</li> <li>10) Terminal connector for an external DC power source (<b>PDC01</b>)</li> <li>11) Terminal connector for an external DC power source and Power Button (<b>PDC11</b>)</li> <li>12) Two or four additional 2.5G LAN ports with Intel 226V chipset (<b>LAN22/LAN42</b>)</li> </ol>					

## FURTHER OPTIONAL ACCESSORIES

- 1) Wide range DC-input 9~36 V, instead of only 19 V (**VOLO1**)
  - 2) Ear-mount brackets, mounting dimensions: 256 mm x 100 mm (**MRS01**)
  - 3) DIN-Rail clip (special clip has holes without thread) (**2x MDR01**)
  - 4) WLAN module with two external antennas (**WMAX2011+CWL01**)
- For more details on accessories, see here: <https://go.shuttle.eu/bpcacc>

## ENVIRONMENTAL SPECIFICATIONS

Option	Operating temperature	Relative humidity
Standard	0 to +40°C	20-80 %, non-condensing
Industrial	-20 to +60°C	20-80 %, non-condensing

Notice the footnote [1]

## CONFORMITY AND CERTIFICATIONS

EMI: CE, FCC Class A, VCCI, RCM, BSMI  
 Safety: CB, cTUVus, BSMI  
 Other: RoHS, ErP, CEC

This device is classed as a technical information equipment (ITE) in Class A, Class A is for product used in commercial and industrial areas. The CE-mark approves the conformity by the EU directives:

- (1) 2014/30/EU relating to electromagnetic compatibility (EMC),
- (2) 2014/35/EU relating to Electrical Equipment designed for use within certain voltage limits (LVD),
- (3) 2009/125/EC relating to eco design requirements for energy-related products (ErP)

**[1] for safe operation in the extended operating temperature range (-20 to +60°C)**, the optional 150W power supply (**PA1501**) is required and industrial-grade RAM/SSD components with an operating temperature range of -40 ... +85 °C are also required

**[2] The DIO expansion kit (DIO11)** comes with the appropriate plug connector included. The digital inputs recognize "Low" at 0-3 Volt and "High" at 5-30 Volt (or open). The digital outputs can handle 0-30V (open collector) with up to 30 mA current.

### [3] Button Cell Battery

- **Purpose:**  
The built-in button cell battery on the mainboard supplies the CMOS memory and the Real-Time Clock (RTC) with power so that certain settings are retained and the internal clock continues to run – even if the PC is completely switched off or disconnected from the power supply.
- **Specification:**  
Model: Lixing KTS CR2032 with cable and connector (Molex 51021-8602, 2-pin, 1.25 mm pitch)  
Type: Lithium metal battery, non-rechargeable, transport identification: UN 3091 (battery is built-in)  
Nominal voltage: 3.0V, nominal capacity: 220 mAh (0.66 Wh)  
Dimensions: 20 mm diameter, 3.2 mm thickness  
Weight: 3.2 g, of which 0.063 g lithium (2.1%)  
Manufacturer: Wuhan Lixing (Torch) Power Sources Co, Ltd, Address: No. 7 Plot, Guandong, Science and Technology Industrial Park, East Lake Development Zone, Wuhan, Hubei, China
- **Certificates:**  
Material Safety Data Sheet (MSDS), UN38.3 test report, ISO 9001 of the manufacturer, EU DoC  
Download here: <https://go.shuttle.eu/Py1Jn>
- **Replace the battery:**  
If the PC issues error messages about the clock or CMOS when starting up, the system's CMOS battery probably needs to be replaced. Use a model with the same technical characteristics as a replacement battery or contact our technical support at [support@shuttle.eu](mailto:support@shuttle.eu).  
The replacement of a CMOS battery may only be carried out by qualified specialist personnel. Improper handling can lead to damage to the mainboard, loss of data or electrical risks. Disconnect the device from the power supply before opening it. Make sure that you do not injure yourself on the sharp metal edges inside the computer. Open the device according to the Quick Installation Guide supplied. Find the battery and pull on the connecting cable so that the plug comes off the mainboard (see photo below). Before pulling out, pay attention to the polarity based on the cable colours (red and black). Carefully remove the old battery, which is stuck on with an adhesive pad. With the new battery, remove the protective film from the adhesive pad and stick the battery in the same position, connect the cable and reassemble the PC. When switching on for the first time, press the "DEL" key, load the "Default Settings" in the BIOS and make any other necessary settings before saving the settings and exiting the BIOS setup.

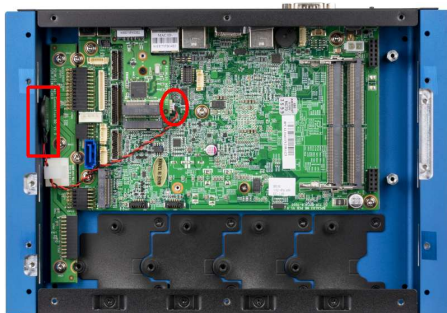
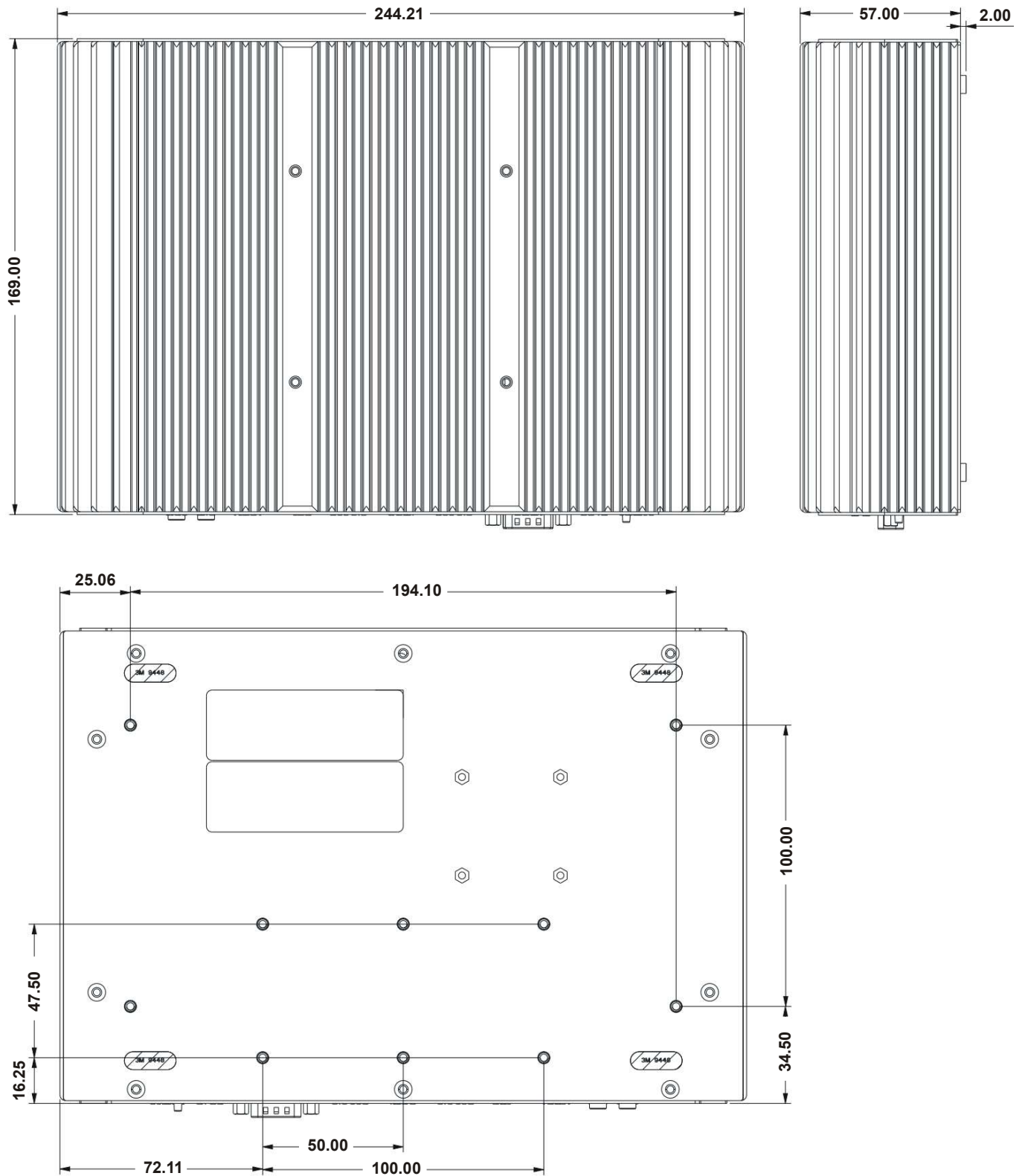

Photo: Position of the button cell battery and the connector on the mainboard with the computer housing open.

- **Disposal:**  
Batteries are classified as hazardous waste and must be disposed of properly. Do not throw them in the household trash. Dispose of batteries at the designated collection points prescribed by law in your country, e.g. at the dealers' collection points.
- **Safety instructions:**  
This product contains a lithium button cell battery that can cause serious or fatal injury within 2 hours if swallowed. Not intended for children under the age of three.

## Technical Drawing



© 2026 Shuttle® Computer Handels-GmbH – All information subject to change without notice. Optional components and accessories are not included. Pictures for illustration purposes only.